



MOTOROLA

intelligence everywhere™

Professional Radio

GP644

User Guide

6866542D03

Issue: April 2003

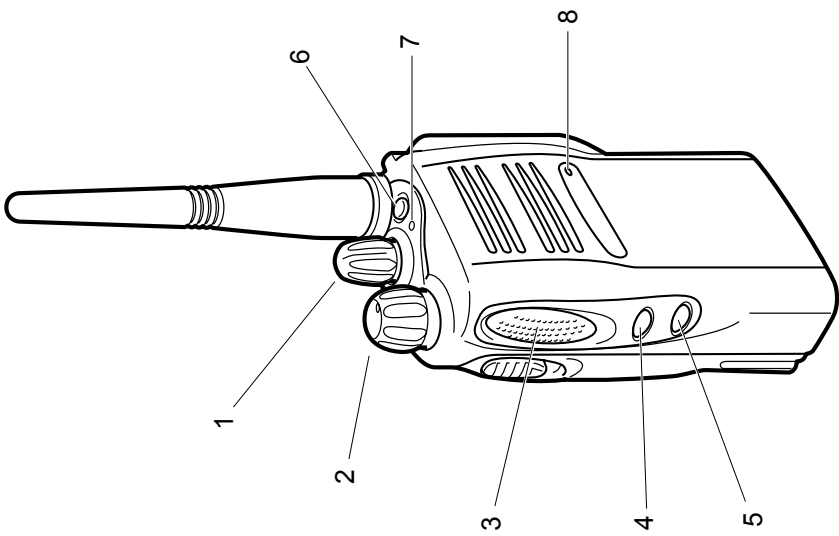
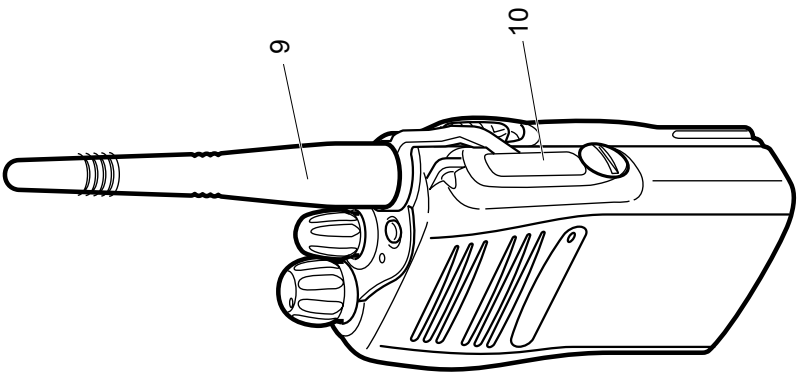

CONTENTS

Radio Overview	3	Radio Calls	13
Operation and Control Functions	3	Making a Call	13
Radio Controls	3	Contact List	13
Programmable Buttons	4	User Absent	13
Audio Signal Tones	5	Dedicated Calls	14
Getting Started	7	Ending a Call	14
Battery Information	7	Cancelling a Call	14
Battery Care and Tips	7	Receiving a Call	15
Recycling or Disposal of Batteries	8	Receiving a Call on a OACSU System	15
Charging the Battery	8	Receiving a Call on a FOACSU System	15
Accessory Information	9	Missed Calls	16
Attaching the Battery	9	Call Diversion	17
Removing the Battery	9	Emergency Calls	18
Attaching the Antenna	10	Personality	19
Removing the Antenna	10	MPT	19
Radio Operation	11	Talkgroup	20
Turning the Radio On-Off	11	Fixed and Dynamic Groups	20
Adjusting the Radio's Volume	11	Conventional Mode	21
Radio Registration	12	Personality Selection	22

Computer Software Copyright

The products described in this manual may include copyrighted computer programmes stored in semiconductor memories or other media. Laws in the United States of America and other countries preserve for Motorola Europe and Motorola Inc. certain exclusive rights for copyrighted computer programmes, including the right to copy or reproduce in any form the copyrighted computer programme. Accordingly, any copyrighted computer programmes contained in the products described in this manual may not be copied or reproduced in any manner without the express written permission of the holders of the rights. Furthermore, the purchase of these products shall not be deemed to grant either directly or by implication, estoppel, or otherwise, any licence under the copyrights, patents, or patent applications of the holders of the rights, except for the normal non-exclusive royalty free licence to use that arises by operation of the law in the sale of the product.

RADIO OVERVIEW

This user guide covers the operation of the GP644 Portable Radio.

Before using this radio, refer to the Product Safety and RF Exposure booklet for Portable Two-way Radios 6864117B25_ enclosed with your radio.

OPERATION AND CONTROL FUNCTIONS

Radio Controls

The numbers below refer to the illustrations on the inside front cover.

- 1. Rotary Knob**
Used as a multi-function scroll key and as a channel selector in Conventional mode.
- 2. On-Off / Volume Knob**
Used to turn the radio on or off, and to adjust the radio's volume.
- 3. Push to Talk Button (PTT)**
Press and hold down this button to talk, release it to listen.
- 4. Clear Button (Side Button 1)**
Used to cancel a call, clear down at the end of a call or Carrier Monitor (Conventional mode).
- 5. Side Button 2 (programmable)**
Personality button, otherwise programmable.
- 6. Top Button (programmable)**
Recommended as Emergency button.
- 7. LED Indicator**
Green: Flashes to indicate NO SERVICE.
Red: On when radio is transmitting.
Red Flashing: When transmitting - battery low.
Green: On to indicate monitor mode active (Conventional Mode).
Red Flashing: When receiving - channel busy (Conventional Mode).
- 8. Microphone**
- 9. Antenna**
- 10. Accessory Connector**
Connects headsets, remote speaker/microphones and other accessories. Replace attached dust cap when not in use.

Programmable Buttons











Several of your radio buttons can be programmed (by your dealer) to activate the radio features.







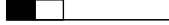

The following table shows the features that can be assigned to the Top button and Side Button 2.

Feature	Description
Dedicated Call/ Emergency	To make a call to a pre-determined number. This can be an emergency number, effectively activating an Emergency Call.
Personality	To select one of two radio personalities, (e.g. MPT trunking system or conventional system). This will normally be Side Button 2.
Missed Calls	To select the Missed Call list. This is a list of calls received and stored by the radio when you were unable to take the call.

Audio Signal Tones (Normal Tones)

High pitched tone Low pitched tone

Tone	Signal	Description
Self test		Power up.
Tone A		Call clear indication.
Tone B		Traffic channel allocated or PTT/ Mic/ Loudspeaker enabled.
Tone C1		System busy.
Tone C2		Unavailable.
Tone C3		Called party busy.
Tone C4		Invalid number.
Tone D		Call set up in progress, wait for further indications.
Tone F		Transaction confirmed, called unit will call back.
Tone G		Look at display for call set up or System information.
Tone H		Invalid entry.

Tone	Signal	Description
Key click		Confidence tone when any key pressed or speech limitation alert.
Fail tone		Hardware error or Call timed out (conventional mode).
Tone I		Low battery warning.
Tone L1		1st Personality.
Tone L2		2nd Personality.
Tone M1		Talkgroup Confirmation.
Tone M2		Talkgroup unavailable.
Tone N1		Out of range alert.
Ring tones	Standard/ English/French/ General	Incoming call, press PTT, then wait for further indications.

Audio Signal Tones (Alternative)

High to Low pitched tones



Tone	Signal	Description
Self test		Power up.
Tone A		Call clear indication.
Tone B		Traffic channel allocated or PTT/ Mic/ Loudspeaker enabled.
Tone C1		System busy.
Tone C2		Unavailable.
Tone C3		Called party busy.
Tone C4		Invalid number.
Tone D		Call set up in progress, wait for further indications.
Tone F		Transaction confirmed, called unit will call back.
Tone G		Look at display for call set up or System information.

Tone	Signal	Description
Tone H		Invalid entry.
Key click		Confidence tone when any key pressed or Speech limitation alert.
Fail tone		Hardware error or Call timed out (conventional mode).
Tone I		Low battery warning.
Tone L1		1st Personality.
Tone L2		2nd Personality.
Tone M1		Talkgroup Confirmation.
Tone M2		Talkgroup unavailable.
Tone N1		Out of range alert.
Ring tones	Standard/ English/French/ General	Incoming call, press PTT, then wait for further indications.

GETTING STARTED

BATTERY INFORMATION

Battery Care and Tips

This product is powered by a nickel-metal-hydride (NiMH) or lithium-ion rechargeable battery.

The following battery tips will help you obtain the highest performance and longest cycle life from your Motorola rechargeable battery.

- Charge your new battery overnight (**14-16 hrs**) before using it to obtain maximum battery capacity and performance.
- Charging in non-Motorola equipment may lead to battery damage and void the battery warranty.
- When charging a battery that is attached to the radio, turn the radio off to ensure a full charge.
- The battery should be at about 25°C (room temperature) whenever possible. Charging a cold battery (below 10°C) may result in leakage of electrolyte and ultimately, in failure of the battery.
- Charging a hot battery (above 35°C) results in reduced discharge capacity, affecting the performance of the radio. Motorola rapid-rate battery chargers contain a temperature-sensing circuit to ensure that the battery is charged within these temperature limits.
- New batteries can be stored up to two years without significant cycle loss. Store new/unused batteries in a cool dry area.
- Batteries which have been in storage should be charged overnight.
- Do not return fully charged batteries to the charger for an “extra boost”. This action will **significantly** reduce cycle life.
- Do not leave your radio and battery in the charger when not charging. Continuous charging will shorten battery life. (Do not use your charger as a radio stand.)
- For optimum battery life and operation use only Motorola brand chargers. They were designed to operate as an integrated energy system.

Recycling or Disposal of Batteries

Motorola endorses and encourages the recycling of all re-chargeable batteries. Contact your local Motorola dealer for further information.

Charging the Battery

If a battery is new, or its charge level is very low, indicated by high pitched warning tones, you will need to charge the battery before you can use it in your radio.

Note: Batteries are shipped uncharged from the factory. New batteries could prematurely indicate full charge, charge a new battery for 14-16 hrs before initial use.

Charger LED	Status
Red	Battery is charging
Green	Battery is fully charged
Flashing Red *	Battery is unchargeable
Flashing Yellow	Charger is getting ready to charge
Flashing Green	Battery is 90% charged

* Battery is damaged. Please contact your dealer.

1. Place the radio with the battery attached, or the battery alone, in the charger.
2. The charger's LED indicates the charging progress.

Battery chargers will charge only the Motorola authorized batteries listed below; other batteries will not charge.

Part No.	Description
JMNN4023	Lithium-Ion
JMNN4024	Lithium-Ion High Capacity
JMNN4025	NiMH Factory Mutual

ACCESSORY INFORMATION

Attaching the Battery

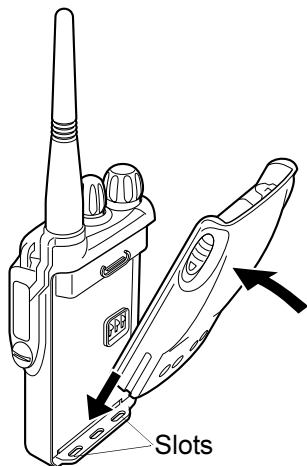

1. Fit the extensions at the bottom of the battery into the slots at the bottom of the radio's body.
2. Press the top part of the battery towards the radio until you hear a click.

Removing the Battery

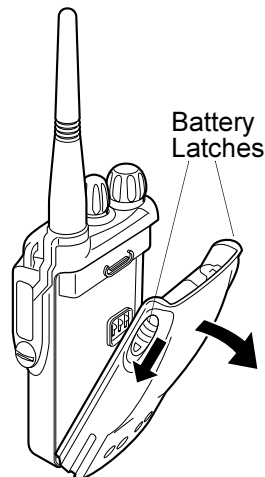

1. Turn off the radio, if it is turned on.
2. Slide the battery latches, on both sides of the battery, downwards.
3. Pull the top part of the battery away from the radio's body, and remove the battery.

Attaching the Antenna

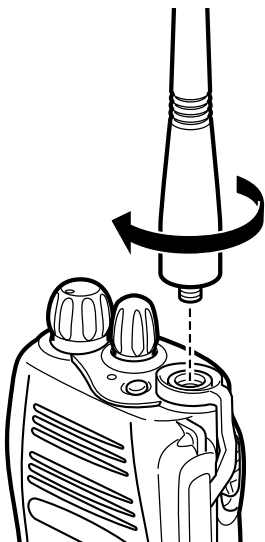

1. Align the threaded end of the antenna with the radio's antenna connector.
2. Turn the antenna clockwise to fasten it.

Removing the Antenna

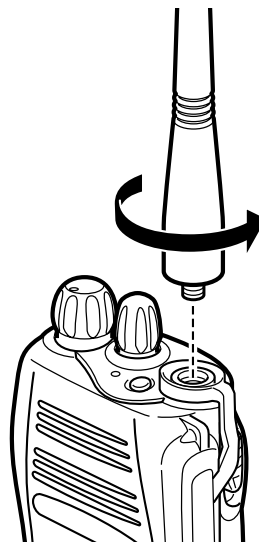

1. Turn the antenna counterclockwise until you can remove it.

RADIO OPERATION

Turning The Radio On or Off

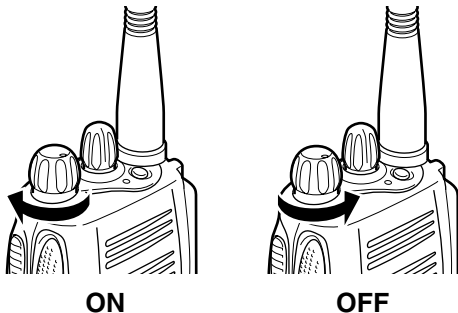

- To turn the radio on, turn the **On-Off/Volume Control** knob clockwise.
- To turn the radio off, turn the **On-Off/Volume Control** knob counterclockwise until you hear a click.

Adjusting the Radio's Volume

- Turn the **On-Off/Volume Control** knob to adjust the volume level.

Radio Registration

When turned on, the radio enters a self test routine, the self test tone will sound and the LED will light green. If the radio fails the self test a continuous low tone will sound until the radio is turned off .

Note: If the radio fails the self test routine, consult your dealer.

When the self test is complete the radio will scan for system access with the LED on the top of the radio flashing GREEN.

The radio personality will be the one last used prior to the radio being switched off. To check the radio personality or select a new personality refer to PERSONALITY - **Personality Selection**.

When a system is acquired, the green LED will go off.

RADIO CALLS

Making a Call

The radio is capable of making a variety of calls, including calls to individual radios, groups of radios and calls to private and public telephone systems.

Before you can make a call the radio must be in the IDLE STATE, i.e. a personality has been selected and no call is in progress.

The radio can make calls by using the **Contact List or Dedicated Calls**.

Contact List

The contact list allows access to up to 16 preprogrammed numbers using the rotary knob (1) when the radio is in the IDLE STATE. Use the rotary knob to scroll through the list and select the required number indicated on base of the knob. Make the call by:

- 1 PTT button to make radio call.
The radio sends out its ID and sounds a tone.

- 2 After the call is set-up, press PTT button and talk with your mouth 2.5-5 cm from microphone. Release PTT to listen.
- 3 When finished with call.
- 4 CLEAR BUTTON Tone A sounds

If a contact list number is selected but no call request is sent, tone H sounds and the radio reverts to the IDLE STATE.

User Absent

User Absent is a network feature which may be enabled in your radio. With this feature enabled, entry into the user absent mode is automatic and any calls received when you are away from your radio will be put into the Missed Calls list automatically and the message "Will call back" sent to the caller. When you return to your radio, check whether tone G sounds every 10 seconds which indicates that your radio is in user absent mode. Press any button to exit user absent mode and return the radio to the idle state for normal operation.

Dedicated Calls

Dedicated calls can be made from a preprogrammed Dedicated Call button. Press the Dedicated Call button to make a call to a commonly used pre- programmed number. The call may also be programmed as an Emergency call, Priority call or Status call.

Ending a Call

Always end a call by:

- 1 CLEAR BUTTON Tone A sounds

Cancelling a Call

At any time while setting up a call it may be cancelled by:

- 1 CLEAR BUTTON Tone D or G sounds

Receiving A Call

There are two types of systems on which the radio may be used, Off Air Call Set Up (OACSU) and Full Off Air Call Set Up (FOACSU).

If you are in doubt about which system you are operating on, please consult your dealer.

Receiving a call on an OACSU system

When the radio is called:

- 1 Tone D sounds LED flashes red. Call is being set up
- 2 Tone B sounds LED extinguished

Receiving a call on an FOACSU system

When the radio is called:

- 1 Ringing tone sounds LED flashes red.
- 2 PTT button to accept call.
(Unless in talkgroup personality, when the radio unmutes automatically for dynamic and fixed group calls)
- 3 Tone D sounds LED flashes red. Call is being set up
- 4 Tone B sounds LED extinguished

Note: The system may have a limited call time and the call may be terminated automatically if this call time is exceeded.

Missed Calls

If a call remains unanswered, the call will be stored by the radio, provided that missed calls has been programmed into your radio.

Only one call can be stored. If the same radio calls more than once the call is only stored once. When the call have been stored by the radio, any further calls received overwrite the stored call.

When a call has been stored by the radio, tone G will sound every ten seconds.

The Missed Call List is entered directly by pressing the Missed Call button when the radio is in the IDLE STATE.

You can call back to the number in the Missed Call list by:

- 1 PTT button to make the call.
The radio sends out its ID and sounds a tone.
- 2 After the call is set-up, press PTT button and talk with your mouth 2.5-5 cm from microphone. Release PTT to listen.
- 3 CLEAR BUTTON Tone A sounds

On a successful call set- up, the entry is automatically deleted from the stack and the radio returns to the IDLE STATE.

An unanswered call may be deleted from the Missed Call list at any time by:

- 1 Press MISSED CALL button to enter list
- 2 Press CLEAR button to delete entry in list

Radio returns to IDLE STATE

Note: The calls in the Missed Call list are not deleted when the radio is turned off. It is not possible to call back status calls.

Call Diversion

Incoming speech calls or status calls can be diverted from your radio or to your radio.

Call diversion and cancellation may be programmed into the Contact List. Please contact your network manager or dealer for further information.

Emergency Calls

An emergency call allows you the highest form of priority calling and normally takes precedence over all other calls.

Your radio can be programmed to give you a one-button quick access to call a particular radio or centre (predefined by your dealer) in emergency situations.

To initiate an emergency call:

- 1 Press the **Emergency** button

Emergency can be stopped by one of the following:

- 1 Switching the radio **Off** and **On** again.
- 2 Pressing the CLEAR button.
- 3 The emergency time duration is reached.

Note: The emergency time duration is programmed into your radio by your dealer.

Your radio may receive an emergency call when:

Tone D or Ring Tone Ring Tone will sound depending on your system

PERSONALITY

The personalities described below are programmed into your radio by your dealer and are accessible via the personality button.

A radio personality contains data such as frequencies, alert tones, permitted calls etc. which determines the operation of your radio. Your radio may be programmed with up to 2 different personalities, selected from MPT, Talkgroup Select and Conventional.

MPT

This personality permits the radio to operate in a trunked mode. Incoming and outgoing calls are set up using a defined set of rules or protocol between your radio and a controller in a similar manner to your home telephone. Your radio 'registers' onto an MPT trunked system as described in GETTING STARTED - **Radio Registration**.

Talkgroup

Talkgroup is an MPT personality following the same rules or protocol, but is primarily for talkgroup calls. In talkgroup personality, talkgroups are contained in a Talkgroup list, similar to the Contact list, which is scrolled and selected using the Rotary Knob (1).

On selection of a talkgroup, you may send and receive calls as described below.

Fixed and Dynamic Groups

These groups form part of the **Talkgroup Personality**, such that when this personality is selected your talkgroup list shows only these groups.

A **fixed** group is a group of users, the address (number/alias) of which is preprogrammed into your radio by your dealer.

A **dynamic** group is a group of users, the address (number) of which is sent to your radio 'over air' at any time via the system controller.

Therefore at any time you may become a member of a dynamic group, able to receive calls and (depending on how your radio is programmed) send calls to that group.

Incoming calls to fixed and dynamic group numbers are detailed in **Receiving a Call**.

To make an outgoing call to a selected talkgroup, press the PTT and speak after the confidence tone.

Calls are cleared in the normal manner.

If the system is busy an engaged tone will be heard, release the PTT and wait for the confidence tone. You may then proceed with the call by pressing the PTT.

Conventional Mode

In the conventional mode your radio operates as a standard two-way radio.

Select the personality number which corresponds to Conventional mode as described in **Personality Selection**.

Use the rotary knob (1) to select the desired channel.

Prior to transmission always make sure that the channel is free (red LED not flashing).

Press the PTT (4) to transmit, release to listen.

The red LED lights while the radio transmits and flashes if the channel is busy.

Some channels may be monitored for activity by pressing the Clear button (3).

In the conventional mode, the radio is equipped with a time out timer. A speech limitation alert tone will sound a few seconds before the transmitter in your radio is switched off. The call timed out tone will sound and continue until the PTT is released.

Personality Selection

Your radio may be programmed with two different personalities, known as Personality 1 and Personality 2.

The personalities programmed may be any of MPT, Talkgroup or Conventional.

Check with your system manager or dealer for the personalities in your radio.

To check the current personality:

- 1 Ensure radio is in IDLE STATE.
- 2 Press Personality button (5)
- 3 If Personality 1: Tone L1 sounds.
- 4 If Personality 2: Tone L2 sounds.

To change the personality:

- 1 Ensure radio is in IDLE STATE.
- 2 Press Personality button (5) for longer than 3 seconds
- 3 If the current personality is Personality 1: Tone L1 sounds.
- 4 At the end of the 3 second button press: Tone L2 sounds indicating that the personality has changed to Personality 2.
- 5 Repeat procedure to revert to Personality 1.