



MOTOROLA

*CEP400
TETRA Portable Terminal*

*Basic User Guide
Bedienungsanleitung
Guide d'utilisation
Guía básica del usuario
Algemene gebruikershandleiding*



When printed by Motorola

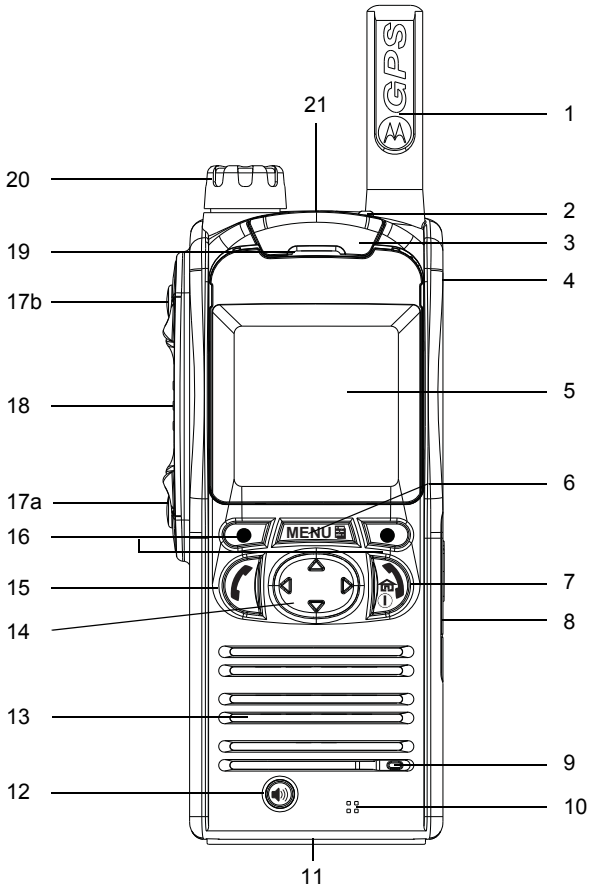

Contents

Safety Information	4
Disposal Information	4
Copyright Information	4
Icon Conventions	5
CEP400 Overview	6
Controls and Indicators	6
Audio Signal Tones	8
Periodic Alert	10
Key, Knob, and Button Overview	10
On-Off/End/Home Key	10
Soft Keys	11
Menu Key	11
Rotary Knob	11
Emergency Button	11
Function Keys	12
Speaker Control Key	13
Volume Adjustment Mode	13
Audio Profile	13
Howling Suppression	13
The LED Status Indicator	14
To Enter the Menu Items	14
To Return to the Previous Level	14
To Exit the Menu Items	14
List of Menu Items	15
The Display	18
Status Icons	18
Menu Icons	20
Inbox Icons	20
Contact Icons	21
Outbox Icons	21

Getting Started	22
Battery	22
Installing the Battery	22
Replacing the Battery	22
Charging the Battery	23
Battery Capacity Information	23
Attaching the Antenna	24
Powering On/Off (On-Off/End/Home Key)	24
Powering On (Emergency Button)	24
Powering On with Transmit Inhibit (TXI) Active	24
Unlocking the CEP400	25
Locking/Unlocking the Keypad	25
Selecting TMO or DMO Operation	26
Entering TMO or DMO	26
Group Calls	27
Favorite Folders	27
Selecting the “My Groups” Folders	27
Adding a Group (TMO/DMO)	27
Deleting a Group (TMO/DMO)	27
Deleting Favorite Folder	28
Selecting a Group	28
Using the Rotary Knob	28
Using the Navigation Key	28
Using Alphabetic Search	28
Using Folder Search	28
Selecting a Folder	29
TMO Group Calls	29
Making a TMO Group Call	29
Receiving a TMO Group Call	29
Receiving a TMO Broadcast Call	29
DMO Group Calls	30
Making a DMO Group Call	30
Receiving a DMO Group Call	30
Exiting DMO	30

Private, Phone, and PABX Calls	31
Creating a Contact	31
How to Dial	31
Dialing a Number	31
Dialing via the Contact List	32
Private Call	32
Making a Private Call	32
Receiving a Private Call	33
Phone and PABX Calls	33
Making a Phone or PABX Call	33
Emergency Mode	34
Entering or Exiting Emergency Mode	34
Sending an Emergency Alarm	34
Hot Microphone Feature	35
Making an Emergency Group Call	36
Silent Emergency Mode	36
Messages	37
Sending a Status Message	37
Sending a User-defined Message	37
Sending a Predefined Message	37
Handling New Incoming Text Messages	37
Handling Unread (New) Messages	38
Tips & Tricks	39
Quick Reference Guide	43

© Motorola Inc., 2009

MOTOROLA and the stylized M Logo are registered in the U.S. Patent and Trademark Office. All other product or service names are the property of their respective owners.

Safety Information



CAUTION

Before using these products, read the operating instructions for safe usage contained in the Product Safety and RF Exposure booklet 6864117B25.

The CEP400 is restricted to occupational use only to satisfy ICNIRP RF energy exposure requirements. Before using the products, read the RF energy awareness information and operating instructions in the Product Safety and RF Exposure booklet (Motorola Publication part number 6864117B25) to ensure compliance with RF energy exposure limits.

Keep this **User Guide** and the **Product Safety and RF Exposure booklet** in a safe place and make it available to other operators in case the accessories are passed on to other people.

Disposal Information



The **European Union Waste of Electrical and Electronic Equipment** directive requires that products sold into EU countries must have the crossed out trashbin label on the product (or the package in some cases). As defined by the WEEE directive, this cross-out trashbin label means that customers and end-users in EU countries should not dispose of electronic and electrical equipment or accessories in household waste.

Customers or end-users in EU countries should contact their local equipment supplier representative or service centre for information about the waste collection system in their country.

Copyright Information

The Motorola products described in this manual may include copyrighted Motorola computer programs stored in semiconductor memories or other mediums. Laws in the United States and other countries preserve for Motorola certain exclusive rights for copyrighted computer programs, but not limited to, including the exclusive right to copy or reproduce in any form the copyrighted computer program.

Accordingly, any copyrighted Motorola computer programs contained in the Motorola products described in this manual may not be copied, reproduced, modified, reverse-engineered, or distributed in any manner without the express written permission of Motorola. Furthermore, the purchase of Motorola products shall not be deemed to grant either directly or by implication, estoppel, or otherwise, any licence under the copyrights, patents, or patent applications of Motorola, except for the normal non-exclusive licence to use that arises by operation of the law in the sale of a product.

This document is copyright protected. Duplications for the purpose of the use of Motorola products are permitted to an appropriate extent. Duplications for other purposes, changes, additions or other processing of this document are not permitted. Only this electronically-saved document is considered to be the original. Duplications are considered merely copies. Motorola, Inc., and its subsidiaries and affiliates do not vouch for the correctness of such kinds of copies.

Icon Conventions

The document set is designed to give the reader more visual cues. The following graphic icons are used throughout the documentation set. These icons and their associated meanings are described below.



WARNING

*The signal word **Warning** with the associated safety icon implies information that, if disregarded, could result in death or serious injury, or serious product damage.*



CAUTION

*The signal word **Caution** with the associated safety icon implies information that, if disregarded, may result in minor or moderate injury, or serious product damage.*

CAUTION

*The signal word **Caution** may be used without the safety icon to state potential damage or injury that is not related to the product.*

NOTE

Notes contain information more important than the surrounding text, such as exceptions or preconditions. They also refer the reader elsewhere for additional information, remind the reader how to complete an action (when it's not part of the current procedure, for instance), or tell the reader where something is located on the screen. There is no warning level associated with a Note.

CEP400 Overview

Controls and Indicators

The numbers below refer to the illustration on the inside front cover.

Number	Description
1	Antenna
2	LED (Indicator)
3	Top Microphone Activated during Simplex, high-audio calls such as Group Calls.
4	External Antenna Connector Used with the digital car kit to connect the RF signal to the external antenna. (At the back of the CEP400)
5	Grayscale Display * Provides alphanumeric text and images within 130 x 130 pixels with backlight, scalable fonts, and contrast.
6	Menu Key Used to enter the main menu and the context sensitive menu.
7	On-Off/End/Home Key <ul style="list-style-type: none">• Press and hold to turn the CEP400 On/Off.• Press to end calls.• Press to return to the Home display (idle screen).
8	Audio Accessory Connector (At the side of the CEP400)
9	Sensor for keypad backlight On/Off
10	Bottom Microphone Activated during Simplex and Duplex, low-audio calls such as Phone Calls.
11	Accessory Connector Provides connection for accessories. (At the base of the CEP400)
12	Speaker Control Key Selects earpiece (low audio), PHF (low audio) or speaker (high audio).
13	Speaker

Number	Description
14	<p>Four Way Navigation Key Press up, down, left or right for list scrolling, while moving around the menu hierarchy, or for alphanumeric text editing. You can enter digits using the Navigation Up and Downs keys.</p>
15	<p>Send Key Used to initiate or answer Duplex calls (such as Phone Calls), or send status and text messages.</p>
16	<p>Soft Key(s) Press to select the option that appears in the display directly above the left or right soft key.</p>
17	<p>Programmable Side Keys 1 and 2 Default programming: upper Side key activates/deactivates Backlight; lower Side key activates Screen Saver. (See also No. 19)</p>
18	<p>Push-To-Talk Button (PTT) Press and hold this side button to talk in Simplex calls, release it to listen. Press to send status and text messages.</p>
19	<p>Earpiece</p>
20	<p>Programmable Rotary Knob Default programming: "Dual" – Press the knob to toggle between "volume" and "list". Side keys (No. 17) operate as programmed. You can enter digits using the Rotary Knob.</p>
21	<p>Emergency Button (on top of the CEP400) Press and hold to enter Emergency Mode, and send Emergency Alarms (as programmed). When the CEP400 is Off, press and hold to power on in Emergency Mode or in normal mode (as programmed).</p>

NOTE

**) Color display is available on your CEP400 as a software orderable feature.*

NOTE













Before using your CEP400 for the first time, remove the plastic lens protector from the display, and charge the battery overnight to ensure battery is initialised to its full capacity.



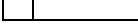

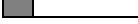





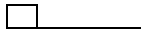

NOTE

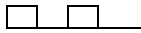



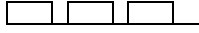

Take care to clean the bottom connector frequently and particularly prior to the programming procedure e.g. with a soft brush (do not use fluids).

Audio Signal Tones

□ = High Tone; ■ = Low Tone;

Description	Type	Repeated
Idle		
<ul style="list-style-type: none"> • Back to Home display • Back to rotary volume use when rotary scroll timer expires • Back to coverage • Back to full service 		Once
Clear to send		Once
Bad key press		Once
<ul style="list-style-type: none"> • Good key press • CEP400 self-test fails at power up • From out-of-service to in-service 		Once
In Call		
Call clear warning		Once
Call waiting tone while Phone or Private Call are pending.		Every 6 seconds, until a call is terminated
Data connected or Data disconnected		Once
Talk Permit sounds upon pressing the PTT		Once (Normal Tone)
		Once (Short Tone)
Talk permit without gateway sounds upon pressing PTT. The tone indicates the gateway is no longer available		Twice
		Once
<ul style="list-style-type: none"> • Talk prohibit • System busy • Time-out timer expire • Called CEP400 not available or busy 		Until you release the PTT.

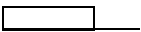
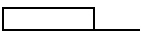
Description	Type	Repeated
Call disconnected or failed due to network		Once
Wrong number dialed		No tone
DMO (Direct Mode) Entering		Once
DMO Exiting		Once
Local site trunking — Entering/Exiting		Once
Phone ring back (sending)		Every three seconds, until the called user answers or call is rejected
Phone busy		Every 0.5 seconds
Status message sent to the dispatcher or failed		Twice
Incoming Calls		
Status message acknowledged by the dispatcher		Four times
Your CEP400 received a Group Call without gateway (setup only)		Once
High-priority Group Call received		Once
Emergency Alarm sent or received		Twice
Emergency Alarm failed		Four times
Emergency Call received		Once
Phone ring, Duplex Private Call (reception)	According to the Ring Style sub-menu setting.	Until you answer or the call is rejected
Private Call received	According to the Ring Style sub-menu setting.	Until you answer or the call is rejected
Private Call ringing to the caller		Until the call is answered

Description	Type	Repeated
Simplex Private Pre-emptive Priority Call (PPC) ring		Every 4 seconds, until the call is answered or rejected.
Duplex Private PPC ring		Every 4 seconds, until the call is answered or rejected.
Limited service		Once, upon entering limited service.
New mail received		Once
New Group Call		Once
General		
Volume setting (earpiece, keypad, speaker)		Continuous
Volume setting (ringer)		While setting the volume.
Transmit Inhibit (TXI)		Once

Periodic Alert

Periodic alert indicates the missed calls and the unread messages. For each indication the unread message tone is played with the orange LED color.



This feature can be disabled/enabled by the user. Press **MENU** and select **> Setup > Tones > Periodic Alert** also to set the period of time between the indications.

Key, Knob, and Button Overview

On-Off/End/Home Key

- Press and hold to turn the CEP400 On/Off.
- Press to end calls.
- Press to return to the Home display.

Soft Keys

Press  or  to select the option that appears in the display directly above the left or right soft key.

Menu Key

Menu key has two functions. Press  to enter:

- **The menu** (when not in the menu). The CEP400 menus allow you to control your CEP400 settings.
- **Context sensitive menu** (when  icon is on and while not on Idle screen) to view a list of items for the current menu.

Rotary Knob

The Service Provider can program the Rotary knob to one of the following uses:

1. **Dual control** – the knob is used as both a volume control and to scroll through lists. Press the knob to toggle between volume and list control (default programming).
2. **List control** – the knob is used to scroll lists (e.g. Talk group lists) or menu items. In this case volume control is always via the Side keys.
3. **Volume control** – the knob is used only as a volume control; turn clockwise to increase the audio volume level.

Press and hold the Rotary knob to lock it, press and hold it again to unlock. Powering Off also unlocks a locked Rotary knob.

Soft Numeric Keypad

Using the *Soft Numeric Keypad* you are able to enter PIN, PUK, Private Numbers and editing contact names using the Rotary Knob or Navigation Key.

Emergency Button

Press and hold this button to enter Emergency Mode.

When the CEP400 is powered down, press and hold this button to power On in Emergency Mode or in standard mode (as programmed).

Function Keys

NOTE For information on the function assigned to each Side and Navigation Key please refer to your Service Provider.

NOTE The required time you need to press function keys to activate a one-touch function is set as default to 1 second. This time may be set, however, by your Service Provider.

Side Keys

The Rotary knob and Side key programming are paired:

Rotary Knob Programming	Side Key Programming
Dual control	Programmed to a one-touch function
List control	○: Volume Up ●: Volume Down
Volume control	Programmed to a one-touch function

When the Rotary knob is programmed to volume control or dual control, the Side keys support the one-touch feature that allows you to select or activate commonly used features by pressing and holding a single key. By default, the upper Side key is set to “Backlight On/Off” and the lower Side key is set to “Screen Saver On”. Please check with your Service Provider.

Navigation Key

The CEP400 supports the one-touch feature that allows you to select or activate commonly used features by pressing and holding an assigned key.

One Touch Private Call

The CEP400 supports the one-touch private call if it is set by the Service Provider. User can dial the last group call originator number via pressing the assigned one touch private call button.

Direct Private Number Dialing

The CEP400 supports the direct private number one-touch dialing (using the Rotary Knob or Navigation Key).

NOTE You can activate the Direct Private Number Dialing by pressing the assigned one touch button. The default setting is the Right Navigation Key. Refer to your Service Provider for details.

Speaker Control Key

Press  to activate the earpiece (low audio), PHF (low audio) or speaker (high audio), depending on the menu settings.

Type of Call	Menu Setting	Key Use
Simplex call (Group*/Private)	Menu > Setup > Audio > Audio Toggle > Spkr Cntrl	Speaker On/Off for Group and Private Calls
	Menu > Setup > Audio > Audio Toggle > Always Loud	Speaker On/Off for Private Call
Duplex call (Private/Phone/ PABX)	-----	Controls speaker/earpiece of the on-going call

* In an Emergency Group Call, the voice sounds from the speaker regardless of the speaker setting.

Volume Adjustment Mode

The Service Provider can enable Volume Adjustment Mode feature. All the settings regarding **Individual** mode are adjustable and retained even if the user switches back to **Common** mode.

In **Common** mode the user adjusts all the **Volumes** at the same time.

To change the volume setting or settings, press  > **Setup** > **Set Volume**.

Audio Profile

An audio profile is a profile that adjusts the audio parameters of the terminal to fit its current operating environment.

To select an Audio Profile, press  and select **Setup > Audio > Audio Profile**. Scroll and choose your required template.

Howling Suppression

Howling Suppression is a mode of operation that eliminates howling effect.



To enable or disable Howling Suppression, press  and select **Setup > Audio > Howling Supr**. Scroll and choose respectively Enabled or Disabled.

The LED Status Indicator

The LED indicator shows the states of your CEP400.

Indicator	Status
Solid green	In use
Flashing green	In service
Solid red	Out of service
Flashing red	Connecting to a network/Entering DMO
Solid orange	Transmit Inhibit (TXI) in service / Channel busy in DMO
First solid then flashing orange	Incoming call
No indication	Switched off

To Enter the Menu Items

1. Press .
2. Scroll to the required item, press **Select** or  to select.

To Return to the Previous Level

Press **Back** or .

To Exit the Menu Items

Press .

NOTE Your CEP400 may exit if no key press is detected for a time-out period.

List of Menu Items

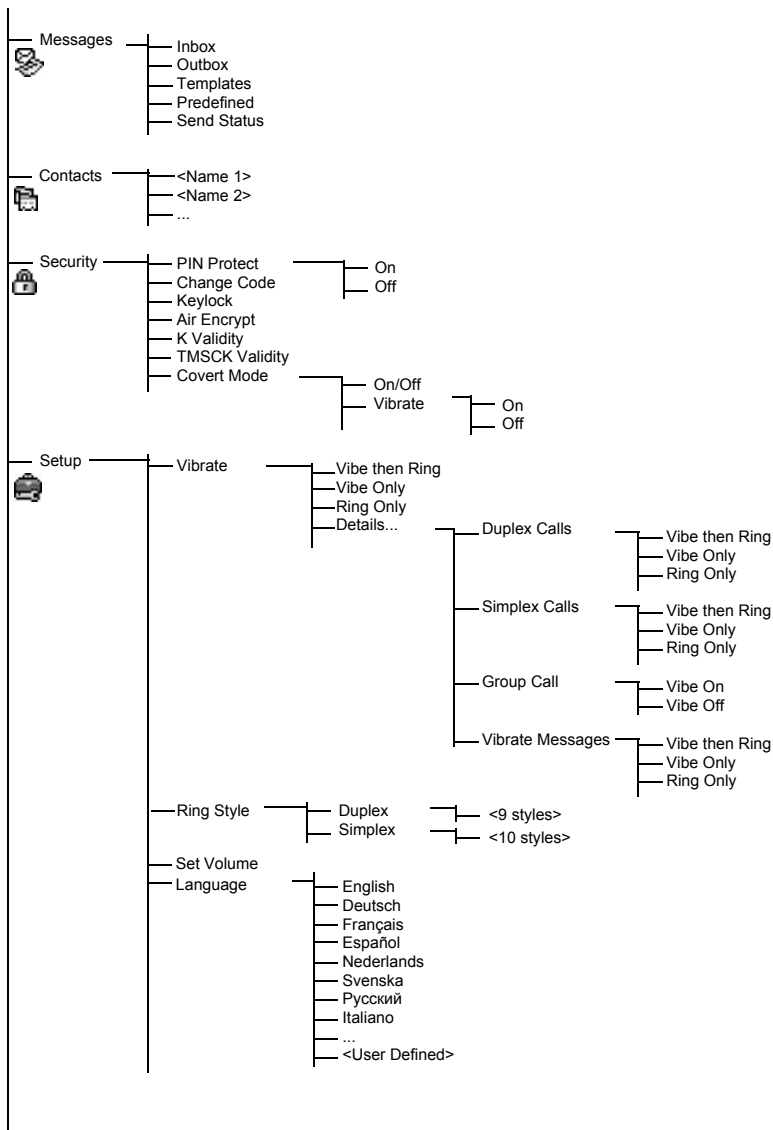

See next page

List of Menu Items (Cont'd)

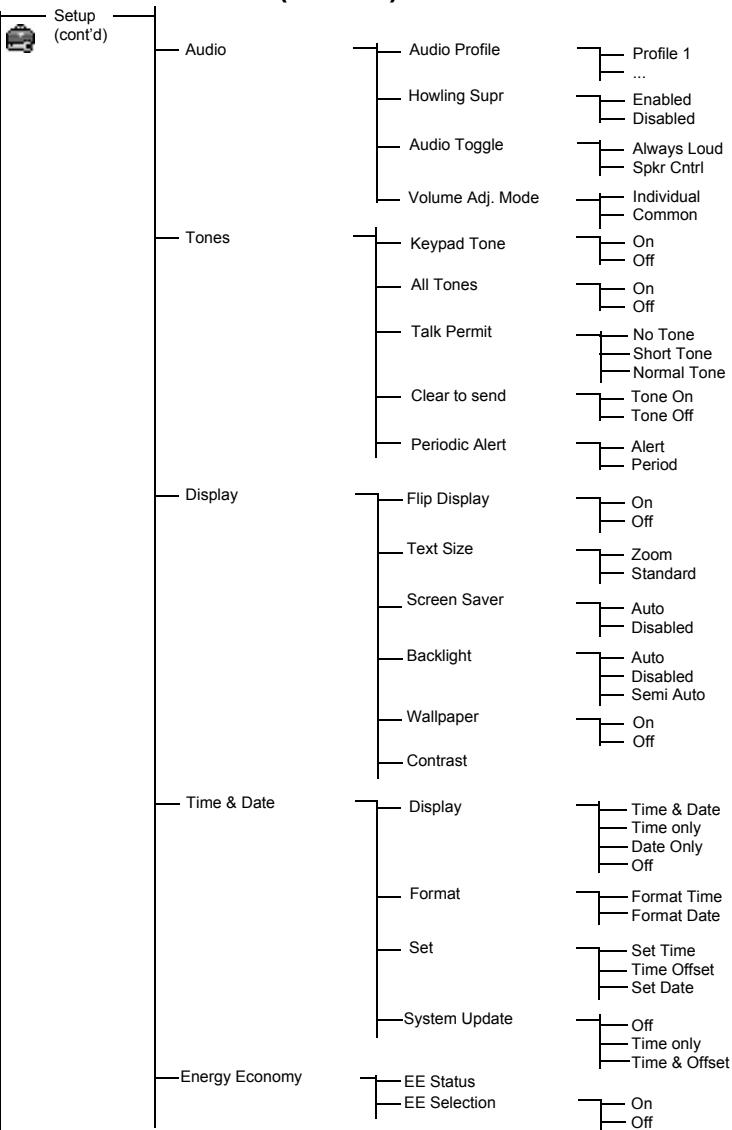

See next page

List of Menu items (Cont'd)

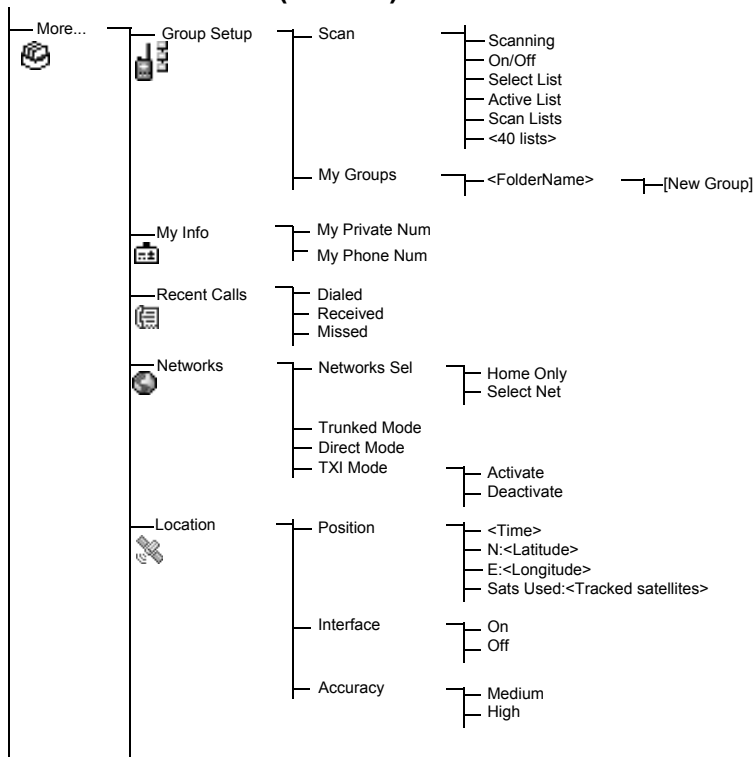

NOTE







This is the standard menu layout. Your Service Provider may enable/disable some menu items or change their names.















The Display

When you use your CEP400, icons appear on the display to indicate the following conditions.

Status Icons









Status icons appear when your phone is engaged in certain activities or when you have activated certain features.

Status Icon	Description
Trunked Mode Operation (TMO)	
	Signal Strength Allows you to check signal strength. More bars indicate a stronger signal.
	No Service
	Scan Indicates scanning is activated in the CEP400.
Direct Mode Operation (DMO)	
	Signal Strength Indicates an incoming Direct Mode Group Call.
	Direct Mode Displayed when the CEP400 is in Direct Mode.
	DMO Gateway Indicates that gateway is selected. The icon has three states: Solid – while the CEP400 is synchronised with the gateway. Flashing – while the CEP400 is not synchronised or during attachment. No icon – during a terminal to terminal and repeater call.
	DMO Repeater Displayed when the repeater option in DMO is selected. This icon has three states: Solid – while the terminal has detected the repeater (i.e., when the terminal receives a presence signal). Blinking – while the terminal has not detected the repeater or during attachment. No icon – during a terminal to terminal and gateway call.
General Icons	

Status Icon	Description
	All Tones Off / Duplex & Simplex Ring Muted Indicates that all alert tones are off in the CEP400 or both Simplex Ring volume is set to 0 and Duplex Ring volume is set to 0.
	Simplex Ring Muted Indicates that Simplex Ring volume is set to 0 and Duplex Ring volume is set to more than 0.
	Duplex Ring Muted Indicates that Duplex Ring volume is set to 0 and Simplex Ring volume is set to more than 0.
	Vibrate On Indicates that the CEP400 will vibrate to alert you of an incoming call.
	Vibrate then Ring Indicates that the CEP400 will vibrate then ring to alert you of an incoming call.
	Speaker Off (Low Audio) Indicates that the audio will sound through the earpiece. (See detailed explanation of Speaker Control key.)
	Low Audio Indicates that the audio mode is changed to low.
	High Audio Indicates that the audio mode is changed to high.
	Earpiece Connected Indicates that the earpiece is connected.
	Battery Strength Shows the charge in your battery. Full icon is full charge.
	Emergency Appears while the CEP400 is in Emergency Mode.
	List Scrolling Displayed to indicate that the Rotary knob use is list scrolling, as long as this use is selected.
	New Message Has Arrived Indicates a new message just arrived.
	New Message(s) in Inbox Indicates that you have unread messages in your inbox.



Menu Icons



The following icons make it easy to identify the menu items at first glance.

Menu Icon	Description
	Main Menu Items/Context Sensitive Menu Appears above  if the main menu items/context sensitive menu are active.
	Messages <ul style="list-style-type: none">• Send status messages,• Send text messages (free text or according to user defined or predefined templates),• Receive messages in inbox.
	Contacts Add, search, edit, or erase entries in the contact list.
	Security Lets you turn On/Off and verify security features, and change passwords.
	Setup Allows you to customise your CEP400.
	More... Contains more customisable menu items.
	Scroll Bar Indicates navigation among items that occupy more than one screen. If all items appear in one screen, the scroll bar is empty.

Inbox Icons







The following icons indicate the status of messages in the inbox.

Inbox Icon	Description
	Unread (New) Message Indicates that you have not read the message yet.
	Read (Old) Message Indicates that you have read the message.
	Sender Information in Message View Indicates sender information (name or number).

Inbox Icon	Description
	Time and Date Stamp in Message View Indicates the time and date of message arrival.
	Delivery Status Received Indicates delivery status for Store & Forward messages.



Contact Icons

In the contact list display, the following icons may appear next to the contact numbers to indicate the type of stored number.

Contact Icon	Description
	Private ID Number
	Mobile Phone Number
	Home Phone Number
	Work Phone Number
	PABX Number
	Other Phone Number
	Pickers Indicate more than one number is stored with the contact.

Outbox Icons

In the Outbox submenu those three icons indicate the process of sending the Store & Forward messages. For more information please contact your Service Provider.

Outbox Icon	Description
	Delivery in Progress
	Delivery Accomplished
	Delivery Failed

NOTE Only Store & Forward messages are stored in Outbox.

Getting Started

Battery

Installing the Battery

1. Remove the battery from its protective clear plastic case.
2. Insert the battery top into the compartment as illustrated.
3. Carefully press the battery bottom downward until it clicks into place.

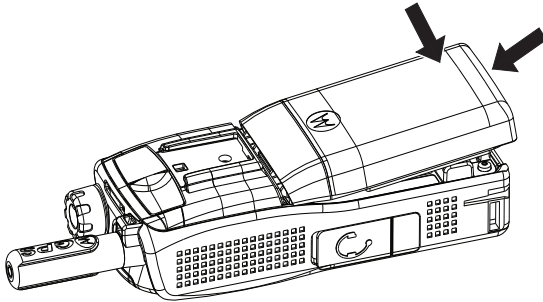

Replacing the Battery

1. To remove the battery, push the latch on the bottom.
2. Lift the bottom of the battery out.
3. Replace the battery.

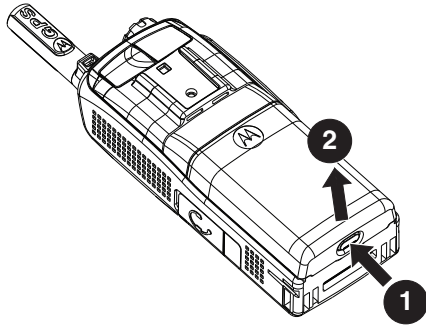

Charging the Battery

Motorola approved chargers provide optimum performance. Other chargers may not fully charge your Motorola Lithium-Ion battery or may reduce the life of the battery.

The CEP400 can be either **On** or **Off** during charging.

1. Insert the connector on the charger into the socket at the base of the CEP400. Select the required plug adapter (UK or European type) and connect to the charger. Then plug the charger into a suitable mains socket.
2. The CEP400 displays the **Charger Connected** message only if the CEP400 is **On** when connecting the charger. If the CEP400 is **Off**, the display shows an icon of the battery in charging.

The Battery icon shows the charging status (see below).



Empty



Full



Empty



Full

Battery Capacity

Battery Charge Progress

Battery Capacity Information

Information	Description
Green icon	Full (50% – 100% capacity)
Yellow icon	Middle (20% – 50% capacity)
Red icon	Low (10% – 20% capacity)
Empty icon	Very low (5% – 10% capacity)
Low battery message	Less than 5% capacity

Attaching the Antenna

NOTE Turn the CEP400 Off before installing or removing the antenna.

Insert the bottom of the antenna into the screw-in base on the top of the CEP400. Turn clockwise until snug. **Do not force.**

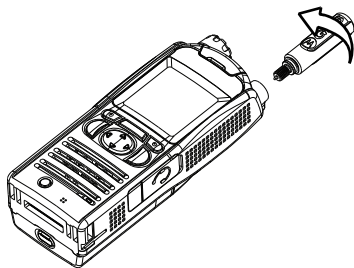

Powering On/Off (On-Off/End/Home Key)

To power **On**, press and hold . Your CEP400 performs a self-check and registration routine. After successful registration, the CEP400 is in service.

To power **Off**, press and hold . You will hear a beep and the **Powering Off** message is displayed.

Powering On (Emergency Button)

Press and hold the Emergency button to power **On**. The CEP400 will power **On** in Emergency Mode or in standard mode (as programmed).

Powering On with Transmit Inhibit (TXI) Active

Transmit Inhibit is a feature allowing you to switch off transmission before entering a Radio Frequency (RF) sensitive area. To activate this feature, press  and select **More... > Networks > TXI Mode > Activate**.



WARNING

*Pressing the Emergency button, even if Transmit Inhibit is activated, causes the CEP400 to transmit immediately. The CEP400 must **NOT** be within the RF sensitive area when entering Emergency Mode.*

The TXI Mode remains active at power **On**. You will be asked whether to leave the TXI Mode **On** or not.



WARNING

Ensure you have left the RF sensitive area before deactivating Transmit Inhibit.

Press the **Yes** soft key to deactivate the TXI Mode. If the CEP400 was previously used in Trunked Mode, it will register to the network. If the CEP400 was previously used in Direct Mode, it will remain in Direct Mode.

Press **No** in Trunked Mode and the CEP400 powers down; press **No** in Direct Mode and you remain in Direct Mode with TXI selected.

Unlocking the CEP400





Your CEP400 may be locked at power up.

To unlock the CEP400 after powering on, enter the code at the prompt using the Rotary Knob or Navigation Key. The CEP400 enters the default Home display.

The unlock code is originally set to 0000. Your Service Provider may change this number before you receive your terminal.



Locking/Unlocking the Keypad

To prevent accidental key/button presses:

Press   to lock the keypad. Press again   to unlock. Service Provider can choose the notification for the Keypad lock and if to lock the **PTT**.

.

NOTE

*When there is an incoming call and the keypad with **PTT** are locked, you can still use the **PTT**, Rotary knob, , , and .*

NOTE

The Emergency button is not locked. Pressing the Emergency button unlocks the keypad.

Selecting TMO or DMO Operation

Entering TMO or DMO

Enter TMO or DMO in one of the following ways:

- From the Home display press **Optns** and select **Direct Mode** if the CEP400 is in TMO.
- From the Home display press **Optns** and select **Trunked Mode** if the CEP400 is in DMO.
- Press **MENU** and select **More... > Networks > Trunked Mode** if the CEP400 is in DMO.
- Press **MENU** and select **More... > Networks > Direct Mode** if the CEP400 is in TMO.
- Press the TMO/DMO one-touch button (if programmed by your Service Provider).

You can make and receive the following types of calls when the CEP400 operates in Trunked Mode:

- Group Calls
- Private Calls
- Phone Calls
- PABX Calls – local (office) extension calls
- Emergency Calls
- Emergency Private Calls.

You can make and receive Group and Private Calls when the CEP400 operates in Direct Mode. This includes Emergency Group Calls.

The CEP400 returns to the Home display when there is no activity for a few seconds.

NOTE *Your terminal can alert you of an incoming call. Select the alert settings in the Vibrate menu and Tones menu items.*

Group Calls

A Group Call is a communication between you and others in a group. A group is a pre-defined set of subscribers enabled to participate in and/or invoke a Group Call.

Groups are organized in maximum three folders. Each folder may contain folders and several groups.

Favorite Folders

You can organise your favorite groups into three folders.

Selecting the “My Groups” Folders

NOTE *Default name for the first favorite folder is “My Groups”.*

From the Home display, press  to quickly access the folders.

Adding a Group (TMO/DMO)

1. Press  and select **More... > Group Setup > My Groups > <FolderName> > [New Group]**.
2. Select a group by alphabetic search (“**TMO/DMO by abc**”). Enter up to 12 characters of the group name. Or select a group by folder search (“**TMO/DMO by Folder**”). Select the folder and select the group. The group is added to the “My Groups” folder.

Deleting a Group (TMO/DMO)

1. Press  and select **More... > Group Setup > My Groups > <FolderName>**.
2. Highlight talkgroup name that you want to delete and select **Delete**.

NOTE *To delete all the groups press  and select **Delete All**. This option is available only if the Service Provider enables it.*

3. Press **Yes** to confirm.

Deleting Favorite Folder

1. Press **MENU** and select **More... > Group Setup > My Groups**.
2. Highlight a group folder name and press **MENU**.
3. Select **Delete Folder**.
4. Press **Yes** to confirm.

NOTE *You cannot delete the last favorite folder.*

Selecting a Group

NOTE *When you navigate in the Favorite folders and select a DMO group, your terminal will switch between TMO and DMO (and vice-versa).*

Using the Rotary Knob

(If programmed)

From the Home display, press shortly on the Rotary knob and rotate until the requested group appears.

Group selection occurs:

- After a time-out
- Or, by pressing **Select** (if configured by your Service Provider)

Using the Navigation Key

From the Home display, scroll left or right until the requested group appears. Then press **Select** to confirm selection.

Using Alphabetic Search

From the Home display, press **Optns**. Select a group by abc search ("**TG by abc**"). Scroll through groups sorted by alphabetic order.

Press **Select** to enter the group.

NOTE *Even if the talkgroup exist in couple folders, alphabetic search displays it once.*

Using Folder Search

From the Home display, press **Optns**. Select a group by folder search ("**TG by Folder**"). Select the folder and select the group.

Selecting a Folder

From the Home display, press **Optns**. Select **Folder**, and select the

desired folder. The display shows the last selected group in that folder.

TMO Group Calls

In TMO the CEP400 is used with your Service Provider's infrastructure.

Making a TMO Group Call

1. From the Home display and if this is the required group, press and hold the **PTT**.
2. Wait for the talk permit tone and then speak into the microphone. Release the **PTT** button to listen.

When you start a call, all members of the selected group who have their units turned on, will receive the Group Call.

NOTE *If you are in an on-going Group Call and wish to make a new call, press  to ignore the current call. Start the new call.*

NOTE *The **No Group** message is displayed when you are out of the normal coverage area of your selected group. You must then select a new group that is valid for your working location.*

Receiving a TMO Group Call

Unless it is engaged in a call, your CEP400 will receive the Group Call. To answer the call, press and hold **PTT**.

Your CEP400 shows the group name and the caller's private number or alias if previously stored in your contact list.

Receiving a TMO Broadcast Call

The Broadcast Call (also called Site Wide Call) is a high-priority Group Call from the console operator (or dispatcher) to all users. The CEP400s are configured to monitor a Broadcast Call, but users cannot talk back.

The Broadcast Call pre-empts an on-going Group Call that has the same (or lower) call priority.

DMO Group Calls

In DMO the CEP400 can be used without your Service Provider's infrastructure.

DMO allows communication with other terminals also operating in

DMO, which are on the same frequency and group as your CEP400.

NOTE

In DMO it is only possible to place the following call types: Group Calls, Emergency Group Calls, Private and Private Simplex Calls.

When you start a call, the members of the selected group who have their units turned on will receive the Group Call.

In DMO the CEP400 can communicate with the trunking system (and vice-versa) if the Gateway option is enabled in the CEP400.

Making a DMO Group Call

1. Enter **Direct Mode** by pressing **Optns** and selecting **Direct Mode**.
2. Make sure that you have selected the required group. Press and hold the **PTT** button.
3. Wait for the talk permit tone and then speak into the microphone. Release the **PTT** button to listen.

Receiving a DMO Group Call

You can receive a DMO Group Call only when your CEP400 is in DMO.

Unless it is engaged in a call, your CEP400 will receive the Group Call. To answer the call, press and hold **PTT**.

Your CEP400 shows the group name and the caller's private number or alias if previously stored in your contact list.

Exiting DMO





To exit DMO, press **Optns** and select **Trunked Mode**.

Private, Phone, and PABX Calls

NOTE

If you are in an on-going Group Call wish to make a new call, press  to ignore the current call. Dial the number.

Creating a Contact

1. From the Home display using Direct Private Number Dialing One-Touch Button enter the number editor.
2. Enter the number using the Rotary Button or Navigation Key.
3. Press  and select **Store Number**.
4. In the Store to list select **[New Contact]**.
5. Enter name using the Rotary Knob or Navigation Key. Press **Ok** to confirm.
6. Press  /  and select the type of stored number (such as Private).
OR
 - Press **Change**, the display shows 6 type selections.
 - Press  /  to choose a type of stored number.
 - Press **Select**, the display returns to Contact Details screen.
7. Continue to enter other types and numbers, as you may keep several numbers (Private, Mobile, Home, Work, PABX, Other) for the same person under the same contact name.
8. When finished, press **Done**. Press **Back** to return to Home display.





How to Dial

Dialing a Number

1. From the Home screen using Direct Private Number Dialing One-Touch Button enter the number editor.
2. Dial the number using the Rotary Knob or Navigation Key.
3. Press **PTT** or  depending on the call type.

Dialing via the Contact List

You can also use the contact list to select a number you previously stored. Press **Contcs** and search the stored number by scrolling

( or ) or by entering up to 12 characters of the contact name using alphabetic search. If the contact has more than one number, use  /  to select the number.

Private Call

A Private Call, also called Point-to-Point or individual call, is a call between two individuals. No other terminal can hear the conversation. This call can be:

- a Duplex call (if the system allows) in TMO, or
- a standard Simplex call in TMO or DMO.

Making a Private Call

1. From the Home display press and hold Direct Private Number Dialing One-Touch Button, then enter the number.

OR

From the Contact List select a number.

2. For a *Simplex* call, press and release the **PTT** button. You will hear a ringing tone. Wait for the called person to answer your call. Press and hold **PTT**. Wait for the talk permit tone (if configured) before talking, and release the **PTT** when listening.

For a *Duplex* call, press and release . You will hear a ringing tone. Wait for the called person to answer your call.

3. To end the call, press . If the called person ends the call, the **Call Ended** message is displayed.

NOTE

While Transmit Inhibit is activated, an incoming Private Call is indicated, but you cannot answer the call.

Receiving a Private Call

1. The CEP400 switches to the incoming Private Call. The display shows the caller's identity.
2. To answer an incoming *Simplex* call, press **PTT**. To answer an incoming *Duplex* call (indicated by **Spkr/Erpc** soft keys), press  or green receiver button.

3. To end the call, press .

NOTE *Your terminal can alert you of an incoming call. Select the alert settings in the Vibrate menu and Tones menu items.*

Phone and PABX Calls

The **Phone Call** allows you to call a landline telephone number or a cellular mobile phone number.

The **Private Automatic Branch Exchange (PABX) Call** allows you to call local (office) extension numbers. This type of call needs to be activated by your Service Provider.

In this publication we use “phone number” when referring to these numbers.

NOTE *While Transmit Inhibit is activated, an incoming Phone or PABX Call is indicated, but you cannot answer the call.*

Making a Phone or PABX Call

1. From the Home display press and hold Direct Private Number Dialing One-Touch Button, then enter the number.
OR
From the Contact List select a number.
2. Proceed as for making and receiving Duplex Private Calls.

Emergency Mode

You can send and receive **Emergency Group Calls** in **Trunked Mode** or in **Direct Mode**. If your terminal is configured to operate through a gateway, Emergency calls can be placed through the gateway.

You can initiate an Emergency Group Call to and receive it from:

- selected group (TMO and DMO) (if tactical emergency)
- pre-defined group (if non-tactical emergency).

Contact your Service Provider to know which is the selected mode.

Your Service Provider will configure the Emergency Alarm and Hot Microphone features.

Emergency calls will be allocated emergency priority in the system.

Entering or Exiting Emergency Mode

To enter Emergency Mode, press **and hold** the Emergency button at the top of the CEP400.

NOTE *The required time you need to press the Emergency button is set to default to 0.5 seconds. The time can be configured by your Service Provider.*

NOTE *Pressing the Emergency button activates one or more services. Contact Service Provider for more information.*

To exit Emergency Mode, press and hold **Exit**. Your terminal will switch to the Home display.

Sending an Emergency Alarm

Your CEP400 will send an Emergency Alarm to the dispatcher (if configured by your Service Provider):

- Automatically, upon entering Emergency Mode.
- If you press the Emergency button again while the CEP400 is in Emergency Mode.

After sending the alarm, the display will show one of the following delivery reports:

- **Alarm Sent**
- **Alarm Failed**

In both cases, the display returns within a few seconds to the main screen of the Emergency Mode.

Due to no delivery confirmation in DMO, **Alarm Sent** information confirms only sending the alarm.



WARNING

*Pressing the Emergency button, even if Transmit Inhibit is activated, causes the CEP400 to transmit immediately. The CEP400 must **NOT** be within the RF sensitive area when entering Emergency Mode.*

NOTE

The Emergency Alarm is a special status message sent to the dispatcher monitoring the selected group. This can be used in dispatch systems to highlight emergency calls.

NOTE

Some systems do not support the Emergency Alarm feature when the user is in a "Local Area Service" area.

Hot Microphone Feature

If the Hot Microphone feature was programmed into your CEP400 by your Service Provider, you can make an Emergency Group Call and talk to the dispatcher (and members of your group) without the need to press and hold the **PTT**.

The microphone will stay open for a time period (programmed by your Service Provider). The microphone will stay open until:

- the Hot microphone time period expires
- you press **PTT** during the Hot Microphone period
- you press the **End** key

At the end of the Hot Microphone the **Emgcy Mic Ended** message will be displayed and the CEP400 returns to the Emergency Mode. The Hot Microphone feature is disabled and PTT operation returns to normal.

If required you can resume Hot Microphone by pressing the Emergency button again. Also your Service Provider is able to resume Hot Mic without user interaction by setting Alternating Hot Mic feature.

NOTE

Hot Microphone feature is available in DMO and TMO mode.

Making an Emergency Group Call

- Hot Microphone enabled – to initiate an Emergency Group Call, press and hold **Emergency Button**.
- Hot Microphone disabled – to initiate an Emergency Group Call, press and hold **Emergency Button**. When the display has changed to Emergency Group Call hold **PTT** and wait for talk permit tone (if configured) and talk. Release the PTT to be able to listen.



Silent Emergency Mode

NOTE *Silent Emergency Mode needs to be enabled by the Service Provider to be able to use it.*

To enter Silent Emergency Mode, press **Emergency button**.

Silent Emergency Mode provides no audible and visible indication. All of the key tones are switched off.

To exit the Silent Emergency mode:

- press  simultaneously with 
- press both Side Programmable Keys simultaneously

Messages

Sending a Status Message

Select the desired group, then press **MENU** and select **Messages > Send Status**. Select status and press **↶** or **PTT**.

Sending a User-defined Message

Press **MENU** and select **Messages > Templates**. Scroll and choose your required template. Select **Send**, or press **↶** or **PTT**. Select your mail recipient or enter number. Select **Send**, or press **↶** or **PTT** to send the message.

Sending a Predefined Message

Press **MENU** and select **Messages > Predefined**. Scroll and choose your required template. Press **MENU** and select **View** to view the message. Select **Send**, or press **↶** or **PTT** to send the message.

Handling New Incoming Text Messages

Your CEP400 will alert you of an incoming message and enter the inbox automatically, if there is no on-going activity in the terminal. Scroll to the message and select **Read** soft key. To read a long message, press **More** to read the next page and **Back** to return to the previous page.

Then press **MENU** and select to **Store / Delete / Delete All / Forward**.

NOTE *For Long Text Messages Store and Forward options are not available.*

Handling Unread (New) Messages

Press **MENU** and select **Messages > Inbox**. Scroll to the message and select **Read** soft key. To read a long message, press **More** to read the next page and **Back** to return to the previous page.

Press **MENU** and select to **Store / Delete / Delete All / Reply / Refresh**.

NOTE *Message contains up to 1000 characters.*

NOTE *It is possible to send the message to more than one user. Pick the group from the contact list on your CEP400.*

Tips & Tricks

Home Key

Not sure where you are? Want to get back to Home display?

Press .

Backlight Control

You can either disable backlight (covert operation) or have it automatically turned on, by pressing any key. Third option is semi-auto, which means that only switching on the radio, pressing assigned button to the backlight feature and charging can trigger backlight.

The backlight remains on until the pre-programmed timer runs out.

High/Low Audio Control

You can control audio routing (speaker/earpiece/PHF) for any Private or Group Call via the dedicated Speaker Control key.

However, you can define via the menu to have all Group Calls in high audio ( > **Setup > Audio > Audio Toggle > Always Loud**).

NOTE *High/Low audio control is switched via One Touch Button. Contact your service provider for more information.*

Unified Contact List

You can keep several numbers (Private, Mobile, Home, Work, PABX, Other) for the same person under the same contact name. You can create up to 1000 contacts, and have a total of 1000 private numbers and 1000 phone numbers.

Text Size

You can see the text on the display in two sizes: **Standard** or **Zoomed** ( > **Setup > Display > Text Size**).

Group Capacity

Your Service provider can program up to 2048 groups for Trunked Mode, and up to 1024 groups for Direct Mode.

Flexible Folders

You can ask your Service Provider to define how many groups will be in each folder (up to 256 folders).

“My Groups” Folders

You can select any group (TMO or DMO) and add it to your personal folder.

In the Home display, press  to quickly access your “My Groups” folders.

Options (in the Home Display)

You can easily change folder, select groups, switch between TMO and DMO (and vice-versa), and other functions via the Home display Options.

Easy Navigation while in Menu

When scrolling up/down menu items, try also right/left scrolling. (This will select the item or return to previous level.)

Flipped Display On/Off



When this feature is activated, the contents of the display are flipped upside down. This feature is particularly useful if you have to wear the CEP400 on the shoulder, belt, or lapel and at the same time wish to read the display upside down.

To activate/deactivate, press  and select **Setup > Display > Flip Display**. Or press and hold the pre-programmed one-touch button.

Dialed Call List – Quick Access

From the Home display press  to access the list of the last dialed calls.

Automatic Scrolling via Navigation Key



In a list press and hold  or  for automatic scrolling.

Recent Calls Menu – Quick Access

From the Home display press .

Setting Time & Date

Time and date are synchronized by the infrastructure. When not within the infrastructure signal range you can set the values manually.

- To set time press  and select **Setup > Time & Date > Set > Set Time**. Enter time using navigation key.
- To set date press  and select **Setup > Time & Date > Set > Set Date**. Enter date using navigation key.

- To automatically set date and time press **MENU** and select **Setup > Time & Date > System Update**. Pick one out of three options accordingly to your needs:
 - **Off** – System Update is turned off
 - **Time only** – time is updated
 - **Time & Offset** – the time is updated automatically according to the current time zone when user is in TMO mode. In DMO mode the radio is using its internal clock.

Toggling between Talkgroups

You can switch the last two talkgroups in any mode and between the modes. For example when you are in TMO and would like to switch to the last Talkgroup that was in DMO, press and hold One Touch Button. It works in both ways and in one mode. After powering off, the radio remembers your two last Talkgroups.



CEP400



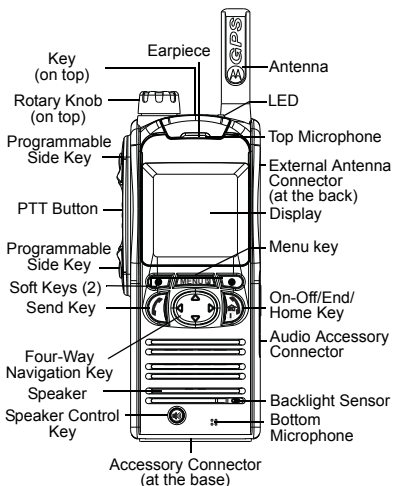



Quick Reference Guide



Turning the CEP400 On/Off

To power the CEP400 on/off, press and hold .

Using the CEP400 Menu System

- To enter the menu, press .
- To scroll through the menu, press  or .
- To select a menu item, press **Select** soft key or .
- To return to previous level, press **Back** or .
- To exit the menu items, press .

Selecting Trunked/Direct Mode Operation

- Your terminal may be configured with a One-touch button to switch between TMO/DMO. Contact your Service Provider for more information.
- From the Home display press **Optns.**, select **Trunked Mode/Direct Mode**.

Making a TMO Group Call

From the Home display navigate to the desired group. Press **Select** soft key (if configured). Press and hold **PTT**. Wait for the talk permit tone (if configured) and talk. Release **PTT** to listen.

Making a DMO Group Call

Enter DMO. Navigate to the desired group. Press **Select** soft key (if configured). Press and hold **PTT**. Wait for the talk permit tone (if configured) and talk. Release **PTT** to listen.

Making a TMO Emergency Group Call

Enter TMO. Press and hold the Emergency button. Emergency alarm is sent automatically. Press and hold **PTT**. Wait for the talk permit tone (if configured) and talk. Release **PTT** to listen. If using "Hot Mic" feature, wait for the "**Emgncy Mic On**" message to appear on the display and talk without pressing PTT. To exit Emergency Mode, press and hold **Exit** soft key.

Making a DMO Emergency Group Call

Enter DMO. Press and hold the Emergency button. Press and hold **PTT**. Wait for the talk permit tone (if configured) and talk. Release **PTT** to listen. To exit Emergency Mode press and hold **Exit** soft key.



Making a TMO Simplex Private Call

From the Home display using Direct Private Number Dialing One-Touch Button enter the number editor. Dial a number using the Rotary Knob or Navigation Key. Press and release **PTT**. Ringing sounds. Called party answers. Wait for the called party to finish speaking. Press and hold **PTT**. Wait for the talk permit tone (if configured) and talk. Release **PTT** to listen. Press  to terminate call.

Making a DMO Simplex Private Call

Enter DMO. From the Home display using Direct Private Number Dialing One-Touch Button enter the number editor. Dial a number using the Rotary Knob or Navigation Key. Press and hold **PTT**. Wait for the talk permit tone (if configured) and talk. Release **PTT** to listen. Press  to terminate call.



Making a Duplex Private Call/Phone/PABX Call

From the Home display using Direct Private Number Dialing One-Touch Button enter the number editor. Dial a number using the Rotary Knob or Navigation Key. Press and release . Ringing sounds. Called party answers. Press  to terminate call.

Answering a Call

Your CEP400 switches to the incoming call and alerts you of the incoming call. To answer the call, press  for Phone/PABX/Duplex Private calls or press **PTT** for all other calls.

Sending a Status Message

Select the desired group, then press  and select **Messages > Send Status**. Select status and press  or **PTT**.

Tips & Tricks

• Home Key

Not sure where you are? Want to get back to Home display? Press .

• Backlight Control

You can disable backlight (covert operation), have it automatically turned on by any key pressed or Semi Auto which turns on the radio by charging and pressing assigned button.

You can also press the upper Side key - just to turn On/Off the backlight (if configured).

• High/Low Audio Control

You can control audio routing (speaker / earpiece) for any Private or Group Call via the dedicated speaker control key.

However, you can define via the menu to have all Group calls in high audio ( > **Setup > Audio > Audio Toggle**).

• Howling Suppression

You can enable the Howling Suppression to eliminate the howling effect ( > **Setup > Audio > Howling Supr**).

• Unified Contact List

You can keep several numbers (Private, Mobile, Home, Work, PABX, Other) for the same person under the same contact name.

• Text Size

You can see the text on the display in two sizes: **Normal** or **Zoomed** ( > **Setup > Display > Text Size**).

• “My Groups” Folder

You can select any group (TMO or DMO) and add it to your personal folder.

In the Home display, press  to quickly access your “My Groups” folder.